

No. 34
2020
web

NITTO

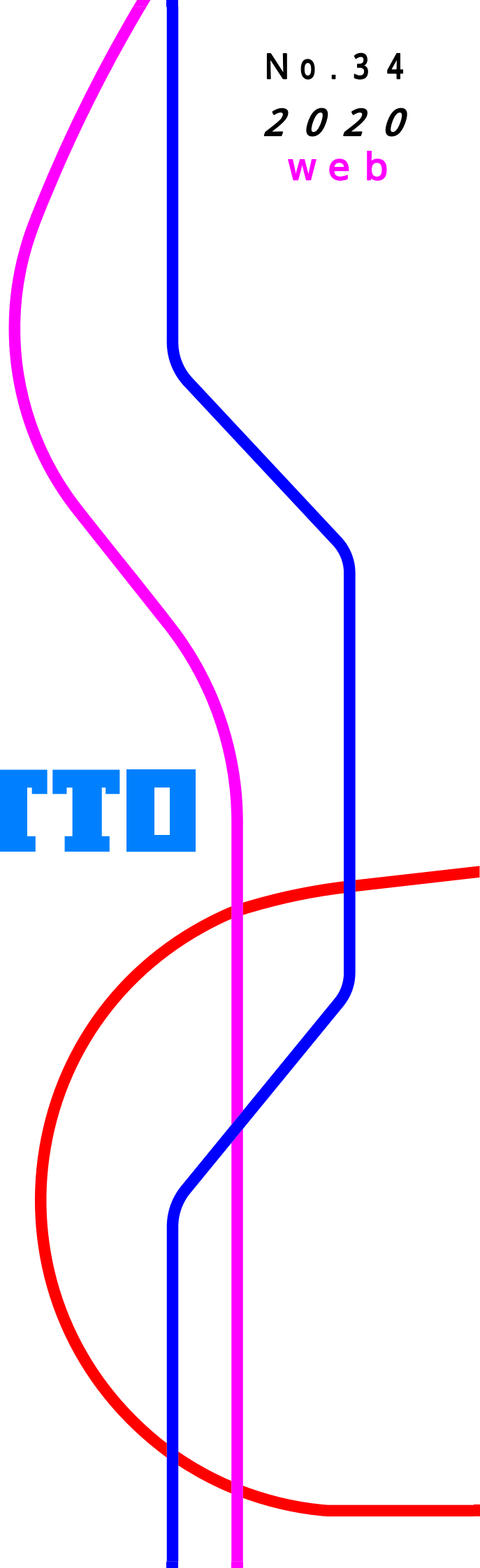



Track Racing



approved by "KEIRIN"
Professional Races in Japan
本品はJKAの競走車部品
適合認定品です



B123 Steel

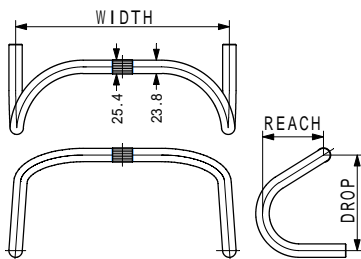

MATERIAL / STEEL TUBE
CENTER DIAM / 25.4
BAR DIAM / 23.8
COLOR / SILVER

MODEL	WIDTH	DROP	REACH	WEIGHT
B123-34	340	170	108	700 g
B123-35	350			710 g
B123-36	360			720 g
B123-37	370			730 g
B123-38	380			740 g
B123-39	390			750 g
B123-40	400			760 g



B123AA

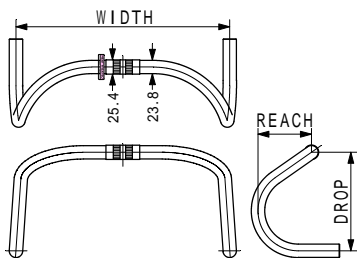

MATERIAL / HEAT TREATED ALUMINUM
CENTER DIAM / 25.4
BAR DIAM / 23.8
COLOR / SILVER ANODIZED

MODEL	WIDTH	DROP	REACH	WEIGHT
B123AA-35	350	175	95	325 g
B123AA-36	360			330 g
B123AA-37	370			335 g
B123AA-38	380			340 g
B123AA-39	390			345 g
B123AA-40	400			350 g



B123Cr.Mo.

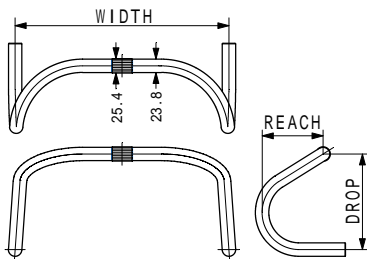

MATERIAL / CrMo STEEL TUBE
CENTER DIAM / 25.4
BAR DIAM / 23.8
COLOR / SILVER

MODEL	WIDTH	DROP	REACH	WEIGHT
B123CrMo-34	340	170	108	665 g
B123CrMo-35	350			675 g
B123CrMo-36	360			685 g
B123CrMo-37	370			695 g
B123CrMo-38	380			705 g
B123CrMo-39	390			715 g
B123CrMo-40	400			725 g
B123CrMo-41	410			735 g
B123CrMo-42	420			745 g



B125 Steel

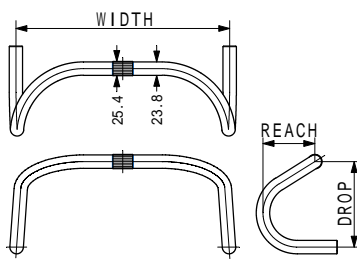

MATERIAL / STEEL TUBE
CENTER DIAM / 25.4
BAR DIAM / 23.8
COLOR / SILVER

MODEL	WIDTH	DROP	REACH	WEIGHT
B125-36	360	152	92	660 g
B125-37	370			670 g
B125-38	380			680 g
B125-39	390			690 g
B125-40	400			700 g
B125-41	410			710 g
B125-42	420			720 g



B125AA

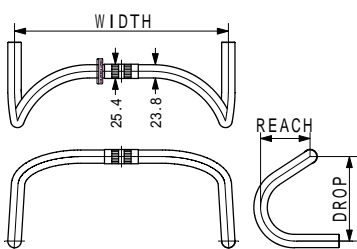

MATERIAL / HEAT TREATED ALUMINUM
CENTER DIAM / 25.4
BAR DIAM / 23.8
COLOR / SILVER ANODIZED

MODEL	WIDTH	DROP	REACH	WEIGHT
B125AA-35	350	150	88	305 g
B125AA-36	360			310 g
B125AA-37	370			315 g
B125AA-38	380			320 g
B125AA-39	390			325 g
B125AA-40	400			330 g

Track Racing



N.J.PRO AA

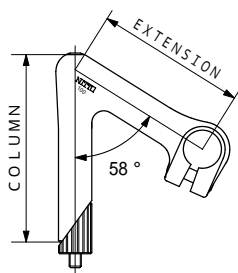

MATERIAL / FORGED ALUMINUM
 BAR CLAMP / 25.4mm
 POST DIAM / 22.2mm
 COLOR / SILVER ANODIZED

MODEL	EXTENSION	COLUMN	WEIGHT
N.J.PRO AA 80	80	125	280g
N.J.PRO AA 90	90		290g
N.J.PRO AA 100	100		300g
N.J.PRO AA 110	110		310g
N.J.PRO AA 120	120		320g



N.J.PRO 58°/65°

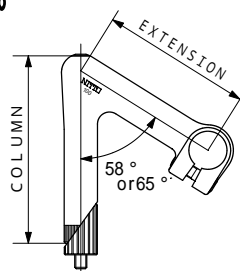

MATERIAL / FORGED STEEL
 BAR CLAMP / 25.4mm
 POST DIAM / 22.2mm
 COLOR / SILVER

MODEL	EXTENSION	COLUMN	WEIGHT
N.J.PRO 70	70	125	365g
N.J.PRO 75	75		373g
N.J.PRO 80	80		380g
N.J.PRO 85	85		388g
N.J.PRO 90	90		395g
N.J.PRO 95	95		402g
N.J.PRO 100	100		410g
N.J.PRO 105	105		418g
N.J.PRO 110	110		426g
N.J.PRO 115	115		434g
N.J.PRO 120	120		442g
N.J.PRO 125	125		450g
N.J.PRO 130	130		458g
N.J.PRO 135	135		467g
N.J.PRO 140	140	475g	



NP

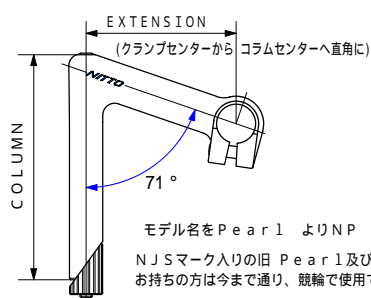

モデル名を Pearl より NP に変更いたします。
 NJSマーク入りの旧 Pearl 及び Pearl を、
 お持ちの方は今まで通り、競輪で使用できます。

MODEL	EXTENSION	COLUMN	WEIGHT
NP 8	80	150	300g
NP 9	90		315g
NP 10	100		330g
NP 11	110		345g
NP 12	120		360g

MATERIAL / FORGED ALUMINUM
 BAR CLAMP / 25.4mm
 POST DIAM / 22.2mm
 COLOR / SILVER ANODIZED

NJ-89



NJS girls keirin stem

MATERIAL / FORGED ALUMINUM
 BAR CLAMP / 25.4mm
 POST CLAMP / 28.6mm
 ANGLE / 73°
 COLOR / SILVER ANODIZED



MODEL	EXTENSION	WEIGHT
NJ-89 60	60	140g
NJ-89 70	70	144g
NJ-89 80	80	148g
NJ-89 90	90	152g
NJ-89 100	100	156g
NJ-89 110	110	160g
NJ-89 120	120	164g

for B123AA, B125AA
 適用ハンドルバー B123AA, B125AA

TRACK RACING SEAT POST

Two-Bolt type, tighten from bottom of the clamp.

トラックレース用 シートピラー
 2本のボルトで下から締める構造



NJ·SP72-W44

MATERIAL / FORGED ALUMINUM
 POST DIAM / 27.2
 / 27.0
 / 26.8
 LENGTH / 210, 250mm
 SADDLE RAIL WIDTH / 44mm
 OFFSET / 22mm
 WEIGHT / 270, 290g
 COLOR / SILVER ANODIZED



NJ·SP72-W30

MATERIAL / FORGED ALUMINUM
 POST DIAM / 27.2
 / 27.0
 / 26.8
 LENGTH / 210, 250mm
 SADDLE RAIL WIDTH / 30mm
 OFFSET / 22mm
 WEIGHT / 245, 265g
 COLOR / SILVER ANODIZED





Track Racing

Over sized

B123CrMo-SSB

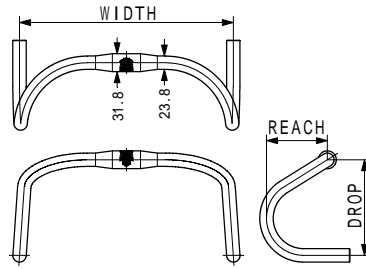

MATERIAL / CrMo STEEL TUBE
 CENTER DIA / 31.8
 BAR DIA / 23.8
 COLOR / SILVER

MODEL	WIDTH	DROP	REACH	WEIGHT
B123CrMo-SSB 370	370	170	108	560 g
B123CrMo-SSB 380	380			570 g
B123CrMo-SSB 390	390			580 g
B123CrMo-SSB 400	400			590 g
B123CrMo-SSB 420	420			600 g

B123AA-SSB

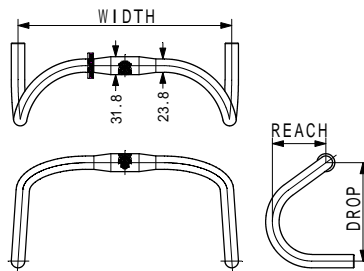

MATERIAL / HEAT TREATED ALUMINUM
 CENTER DIA / 31.8
 BAR DIA / 23.8
 COLOR / SILVER ANODIZED

MODEL	WIDTH	DROP	REACH	WEIGHT
B123AA-SSB 370	370	175	95	340 g
B123AA-SSB 380	380			345 g
B123AA-SSB 390	390			350 g
B123AA-SSB 400	400			355 g
B123AA-SSB 420	420			360 g



CARBON DROPBAR

B123CB (31.8)

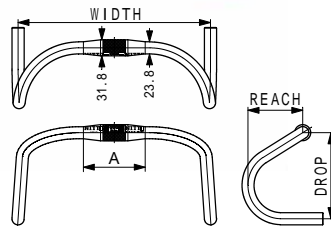

CARBON DROPBAR (for TRACK)

MATERIAL / CARBON FIBER
 CENTER DIAM / 31.8
 BAR DIAM / 23.8
 COLOR / BLACK / BLUE

MODEEL	WIDTH	A	DROP	REACH	WEIGHT
B123CB W370	370	112	170	108	242 g
B123CB W380	380	122			247 g
B123CB W390	390	132			252 g
B123CB W400	400	142			257 g

Mod.90 SSB (31.8)

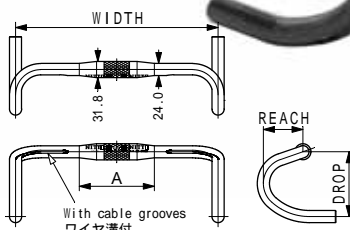

CARBON DROPBAR (for ROAD)

MATERIAL / CARBON FIBER
 CENTER DIAM / 31.8
 BAR DIAM / 24.0
 COLOR / BLACK

MODEEL	WIDTH	A	DROP	REACH	WEIGHT
Mod.90 SSB W400	400	148	128	78	243 g



Road Racing



M106 SSB(31.8)

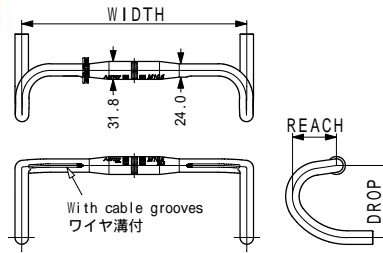

MATERIAL/HEAT TREATED ALUMINUM
 CENTER DIAM/ 31.8
 BAR DIAM/ 24.0
 COLOR/SILVER/BLACK ANODIZED

MODEL	WIDTH	DROP	REACH	WEIGHT
M106SSB-380	380	128	78	330 g
M106SSB-400	400			340 g
M106SSB-420	420			350 g



M106 NAS

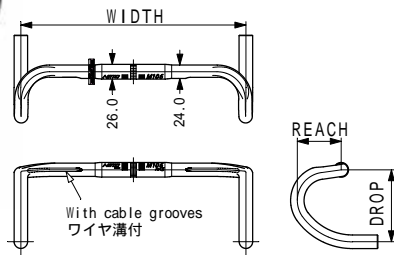

MATERIAL/HEAT TREATED ALUMINUM
 CENTER DIAM/ 26.0
 BAR DIAM/ 24.0
 COLOR/SILVER/BLACK ANODIZED

MODEL	WIDTH	DROP	REACH	WEIGHT
M106NAS-380	380	128	78	300 g
M106NAS-400	400			310 g
M106NAS-420	420			320 g



M186 STI

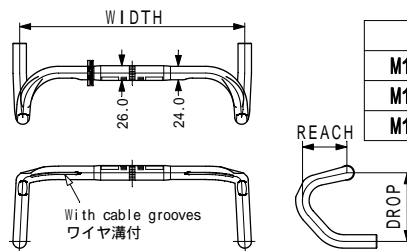

MATERIAL/HEAT TREATED ALUMINUM
 CENTER DIAM/ 26.0
 BAR DIAM/ 24.0
 COLOR/SILVER/BLACK ANODIZED

MODEL	WIDTH	DROP	REACH	WEIGHT
M186STI-380	380	122	80	300 g
M186STI-400	400			305 g
M186STI-420	420			310 g

STIレバーの取付け位置のマークは目安です。
 レバーに合わせて位置を調整して下さい。



M190 Euro80

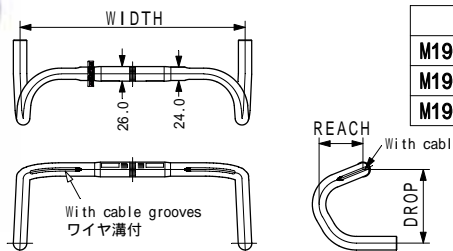

MATERIAL/HEAT TREATED ALUMINUM
 CENTER DIAM/ 26.0
 BAR DIAM/ 24.0
 COLOR/SILVER ANODIZED

MODEL	WIDTH	DROP	REACH	WEIGHT
M190Euro80-380	380	131	80	310 g
M190Euro80-400	400			315 g
M190Euro80-420	420			320 g

With double cable grooves 前後ワイヤ溝付



M151 AAF

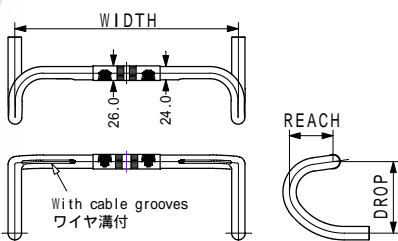

MATERIAL/ALUMINUM
 CENTER DIAM/ 26.0
 BAR DIAM/ 24.0
 COLOR/SILVER ANODIZED

MODEL	WIDTH	DROP	REACH	WEIGHT
M151AAF-380	380	128	78	325 g
M151AAF-400	400			330 g
M151AAF-420	420			335 g
M151AAF-440	440			365 g
M151AAF-460	460			370 g



Road Racing

B105AA-SSB(31.8)

MATERIAL / HEAT TREATED ALUMINUM
 CENTER DIAM/ 31.8
 BAR DIAM/ 23.8
 COLOR/SILVER
 BLACK ANODIZED

MODEL	WIDTH	DROP	REACH	WEIGHT
B105AA-SSB-400	400	135	95	360 g
B105AA-SSB-420	420			370 g
B105AA-SSB-440	440			380 g

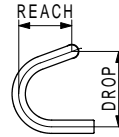
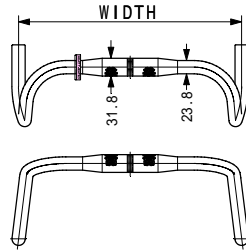

B105AA

MATERIAL / ALUMINUM
 CENTER DIAM/ 25.4
 BAR DIAM/ 23.8
 COLOR/SILVER ANODIZED

MODEL	WIDTH	DROP	REACH	WEIGHT
B105AA-370	370	135	95	300 g
B105AA-380	380			305 g
B105AA-390	390			310 g
B105AA-400	400			315 g
B105AA-410	410			320 g
B105AA-420	420			325 g

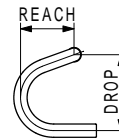
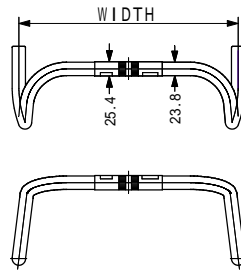

Neat Mod.185

MATERIAL / ALUMINUM
 CENTER DIAM/ 26.0
 BAR DIAM/ 24.0
 COLOR/SILVER ANODIZED

MODEL	WIDTH	DROP	REACH	WEIGHT
Neat Mod.185-380	380	140	82	330 g
Neat Mod.185-400	400			340 g
Neat Mod.185-420	420			350 g

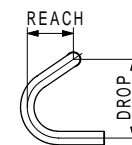
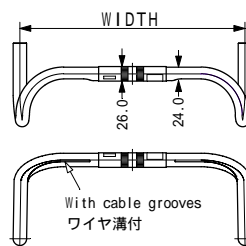

B115AA

MATERIAL / ALUMINUM
 CENTER DIAM/ 25.4
 BAR DIAM/ 23.8
 COLOR/SILVER ANODIZED

MODEL	WIDTH	DROP	REACH	WEIGHT
B115AA-380	380	140	100	315 g
B115AA-400	400			325 g
B115AA-420	420			335 g
B115AA-440	440			390 g
B115AA-450	450			395 g

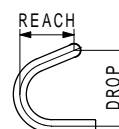
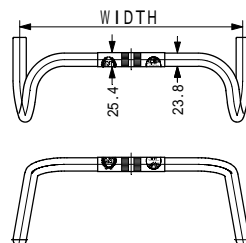

Road Racing



RB-018

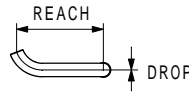
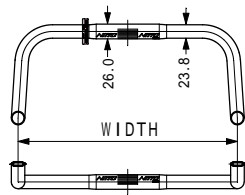

MATERIAL / HEAT TREATED ALUMINUM
 CENTER DIAM / 26.0
 BAR DIAM / 23.8
 COLOR / LIGHT GRAY ANODIZED

MODEL	WIDTH	DROP	REACH	WEIGHT
RB-018-380	380	0	154	260 g
RB-018-390	390			265 g
RB-018-400	400			270 g
RB-018-420	420			275 g



RB-021

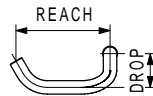
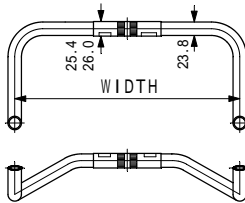

MATERIAL / ALUMINUM
 CENTER DIAM / 25.4 / 26.0
 BAR DIAM / 23.8
 COLOR / SILVER ANODIZED

MODEL	WIDTH	DROP	REACH	WEIGHT
RB-021-380	380	60	167	265 g
RB-021-400	400			270 g
RB-021-420	420			275 g



RB-021-SSB (31.8)

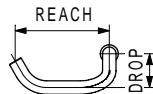
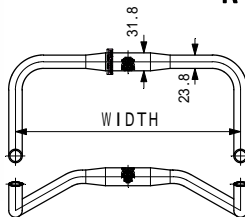

MATERIAL / HEAT TREATED ALUMINUM
 CENTER DIAM / 31.8
 BAR DIAM / 23.8
 COLOR / SILVER ANODIZED

MODEL	WIDTH	DROP	REACH	WEIGHT
RB-021AA-SSB-380	380	60	167	275 g
RB-021AA-SSB-400	400			280 g
RB-021AA-SSB-420	420			285 g



RB-010

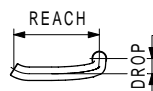
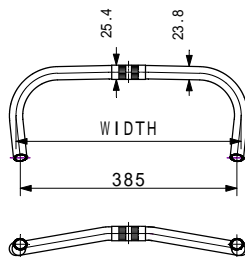

MATERIAL / ALUMINUM
 CENTER DIAM / 25.4
 BAR DIAM / 23.8
 COLOR / SILVER / BLACK ANODIZED

MODEL	WIDTH	DROP	REACH	WEIGHT
RB-010	400	27	152	295 g



RB-030

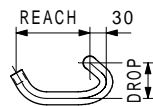
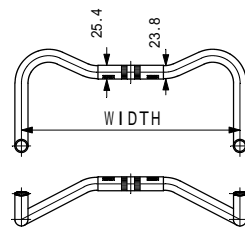

MATERIAL / ALUMINUM
 CENTER DIAM / 25.4
 BAR DIAM / 23.8
 COLOR / SILVER

MODEL	WIDTH	DROP	REACH	WEIGHT
RB-030-380	380	65	135	255 g
RB-030-400	400			260 g
RB-030-420	420			265 g
RB-030-440	440			325 g



RB-030-SSB (31.8)

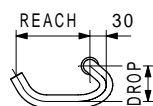
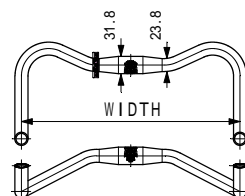

MATERIAL / HEAT TREATED ALUMINUM
 CENTER DIAM / 31.8
 BAR DIAM / 23.8
 COLOR / SILVER

MODEL	WIDTH	DROP	REACH	WEIGHT
RB-030-SSB-380	380	65	135	255 g
RB-030-SSB-400	400			260 g
RB-030-SSB-420	420			265 g
RB-030-SSB-440	440			270 g



Gravel Road



M137 SSB

NEW

MATERIAL/HEAT TREATED ALUMINUM
 CENTER DIAM/ 31.8
 BAR DIAM/ 23.8
 COLOR/SILVER
 BLACK ANODIZED

MODEL	WIDTH	DROP	REACH	WEIGHT
M137 SSB-480	480	128	78	365 g
M137 SSB-500	500			375 g
M137 SSB-520	520			385 g
M137 SSB-540	540			400 g

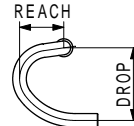
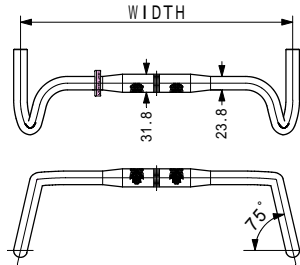

B135AA-SSB

MATERIAL/HEAT TREATED ALUMINUM
 CENTER DIAM/ 31.8
 BAR DIAM/ 23.8
 COLOR/SILVER ANODIZED

MODEL	WIDTH	DROP	REACH	WEIGHT
B135AA-SSB-390	390	120	105	330 g
B135AA-SSB-420	420			340 g
B135AA-SSB-450	450			350 g

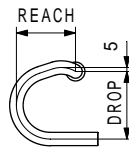
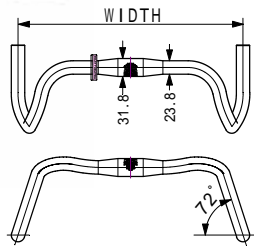

RM-3 SSB(31.8)

MATERIAL/HEAT TREATED ALUMINUM
 CENTER DIAM/ 31.8
 BAR DIAM/ 23.8
 COLOR/SILVER ANODIZED

MODEL	WIDTH	DROP	REACH	WEIGHT
RM-3 SSB-520	520	120	65	285 g
RM-3 SSB-540	540			305 g
RM-3 SSB-580	580			325 g

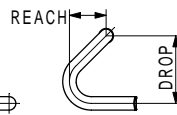
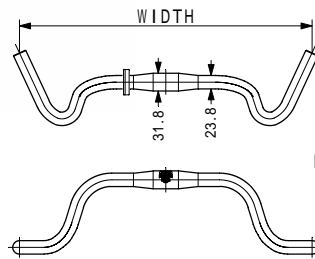

RM-3(25.4)

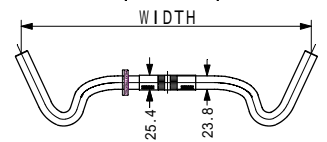

RM-016

MATERIAL/HEAT TREATED ALUMINUM
 CENTER DIAM/ 25.4/ 26.0
 BAR DIAM/ 23.8
 COLOR/SILVER ANODIZED

MODEL	WIDTH	DROP	REACH	WEIGHT
RM-016-26.0	515	50	95	370 g
RM-016-25.4				

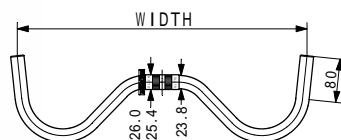



Touring



B130AAF

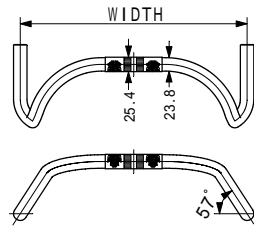

MATERIAL / ALUMINUM
 CENTER DIAM / 25.4
 BAR DIAM / 23.8
 COLOR / SILVER ANODIZED

MODEL	WIDTH	DROP	REACH	WEIGHT
B130AAF-400	400	92	100	300 g

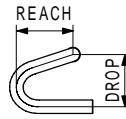

B132AAF

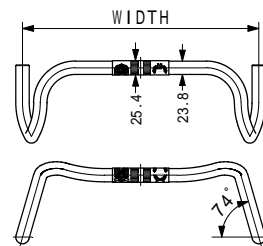

MATERIAL / ALUMINUM
 CENTER DIAM / 25.4
 BAR DIAM / 23.8
 COLOR / SILVER ANODIZED

MODEL	WIDTH	DROP	REACH	WEIGHT
B132AAF-390	390	110	122	310 g
B132AAF-400	400			315 g
B132AAF-410	410			340 g
B132AAF-420	420			345 g
B132AAF-440	440			380 g

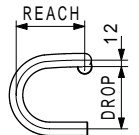

B135AA

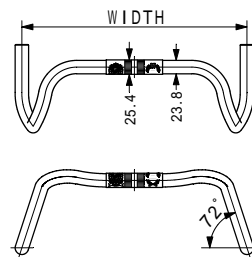

MATERIAL / ALUMINUM
 CENTER DIAM / 25.4
 BAR DIAM / 23.8
 COLOR / SILVER ANODIZED

MODEL	WIDTH	DROP	REACH	WEIGHT
B135AA-390	390	120	105	300 g
B135AA-420	420			315 g
B135AA-450	450			375 g

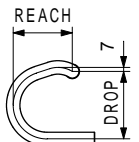

B136AA

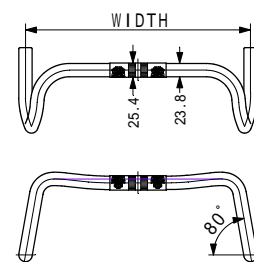

MATERIAL / ALUMINUM
 CENTER DIAM / 25.4
 BAR DIAM / 23.8
 COLOR / SILVER ANODIZED

MODEL	WIDTH	DROP	REACH	WEIGHT
B136AA-400	400	128	100	315 g
B136AA-420	420			320 g

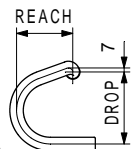

Mod.177

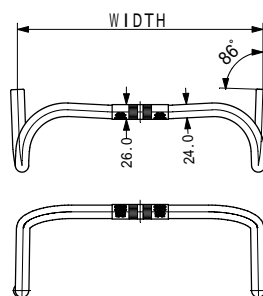

MATERIAL / ALUMINUM
 CENTER DIAM / 26.0
 BAR DIAM / 24.0
 COLOR / SILVER ANODIZED

MODEL	WIDTH	DROP	REACH	WEIGHT
Mod.177-400	400	140	95	330 g
Mod.177-420	420			340 g
Mod.177-440	440			350 g

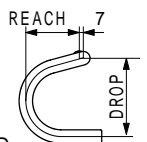

MATERIAL / HEAT TREATED ALUMINUM
 CENTER DIAM / 26.0
 BAR DIAM / 23.8
 COLOR / SILVER ANODIZED

MODEL	WIDTH	DROP	REACH	WEIGHT
Mod.177-460	460	140	95	375 g
Mod.177-480	480			385 g



Urban Cycles

B260AAF

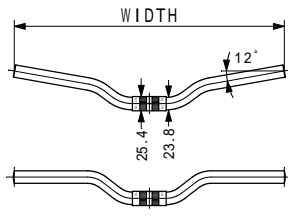

MATERIAL / ALUMINUM
 CENTER DIAM / 25.4 mm
 BAR DIAM / 23.8 mm
 BACK SWEEP / 12°
 COLOR / SILVER / BLACK ANODIZED

MODEL	WIDTH	RISE	DEPTH	WEIGHT
B260AAF	480	35	58	210 g

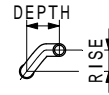

B220AAF

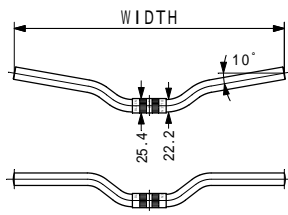

MATERIAL / ALUMINUM
 CENTER DIAM / 25.4 mm
 BAR DIAM / 22.2 mm
 BACK SWEEP / 10°
 COLOR / SILVER ANODIZED

MODEL	WIDTH	RISE	DEPTH	WEIGHT
B220AAF	480	38	58	265 g

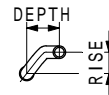

B221AA-HT

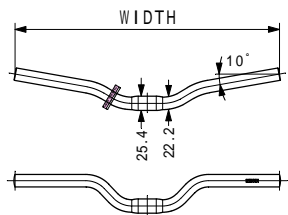
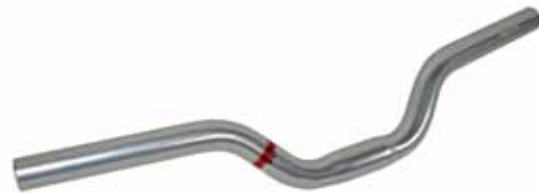

MATERIAL / HEAT TREATED ALUMINUM
 CENTER DIAM / 25.4 mm
 BAR DIAM / 22.2 mm
 BACK SWEEP / 10°
 COLOR / SILVER ANODIZED

MODEL	WIDTH	RISE	DEPTH	WEIGHT
B221AA-HT	470	45	52	275 g

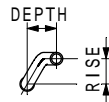

B230AAF

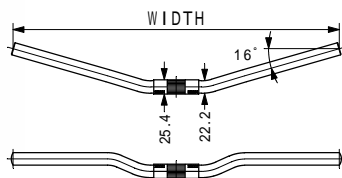
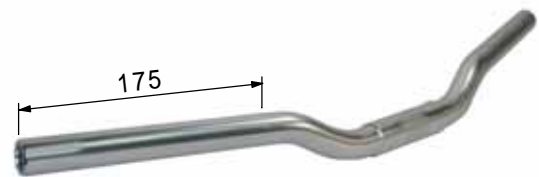

MATERIAL / ALUMINUM
 CENTER DIAM / 25.4 mm
 BAR DIAM / 22.2 mm
 BACK SWEEP / 16°
 COLOR / SILVER ANODIZED

MODEL	WIDTH	RISE	DEPTH	WEIGHT
B230AAF	580	22	68	310 g

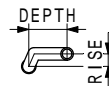

シマノ グリップシフター 装着可

B267AA-SSB

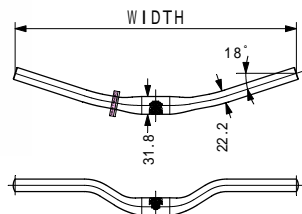

MATERIAL / HEAT TREATED ALUMINUM
 CENTER DIAM / 31.8 mm
 BAR DIAM / 22.2 mm
 BACK SWEEP / 18°
 COLOR / SILVER ANODIZED

MODEL	WIDTH	RISE	DEPTH	WEIGHT
B267AA - SSB	520	38	57	218 g



Urban Cycle Handle bar



RB-006

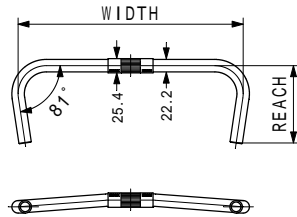

MATERIAL / ALUMINUM
 CENTER DIAM / 25.4
 BAR DIAM / 22.2
 COLOR / SILVER ANODIZED

MODEL	WIDTH	DROP	REACH	WEIGHT
RB-006-380	380	12	137	280 g
RB-006-400	400			290 g
RB-006-420	420			340 g
RB-006-480	480	12	137	310 g

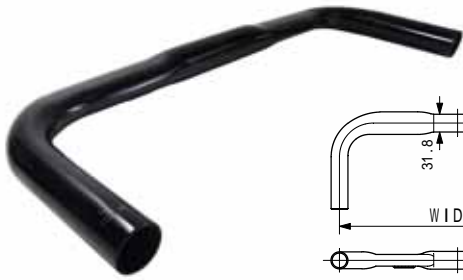

RB-035-SSB(31.8)

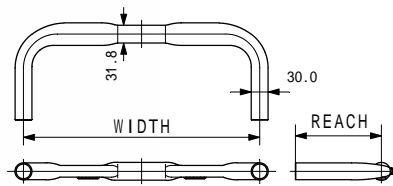

MATERIAL / HEAT TREATED ALUMINUM
 CENTER DIAM / 31.8
 BAR DIAM / 30.0
 COLOR / BLACK ANODIZED
 (Available in Black only.)

MODEL	WIDTH	DROP	REACH	WEIGHT
RB-035 SSB-420	420	0	153	352 g

For SHIMANO METREA

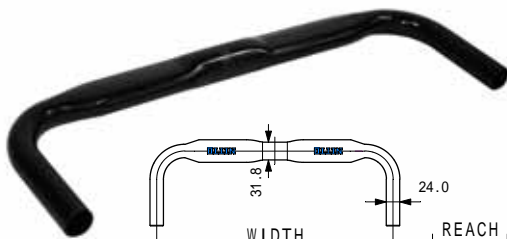

RB-036-SSB(31.8)

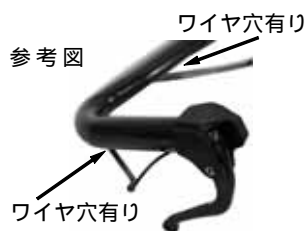
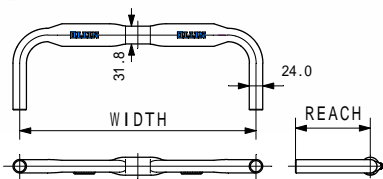

w/holes for internal cable routing

MATERIAL / HEAT TREATED ALUMINUM
 CENTER DIAM / 31.8
 BAR DIAM / 24.0
 COLOR / SILVER / BLACK ANODIZED

MODEL	WIDTH	DROP	REACH	WEIGHT
RB-036 SSB-400	400	0	133	275 g
RB-036 SSB-420	420			285 g

B2522AA-SSB(31.8)

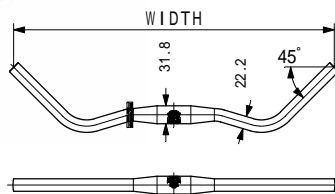

MATERIAL / HEAT TREATED ALUMINUM
 CENTER DIAM / 31.8mm
 BAR DIAM / 22.2mm
 BACK SWEEP / 45°
 COLOR / SILVER ANODIZED

MODEL	WIDTH	DROP	REACH	WEIGHT
B2522AA-SSB-570	570	0	20	335 g
B2522AA-SSB-610	610			350 g



B263AA

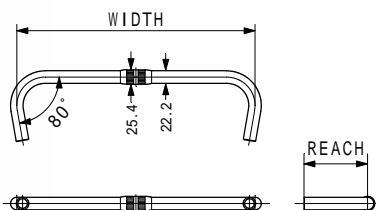

MATERIAL / ALUMINUM
 CENTER DIAM / 25.4
 BAR DIAM / 22.2
 COLOR / SILVER ANODIZED

MODEL	WIDTH	DROP	REACH	WEIGHT
B263AA-340	340	0	112	215 g
B263AA-380	380			270 g
B263AA-420	420			295 g



Standard Urban Cycle Handle bar



B201AA

MATERIAL / ALUMINUM
COLOR / SILVER / BLACK ANODIZED

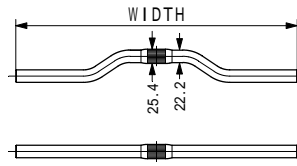

MODEL	WIDTH	RISE	REACH	WEIGHT
B201AA	500	0	35	210 g



B206AA

MATERIAL / ALUMINUM
COLOR / SILVER / BLACK ANODIZED

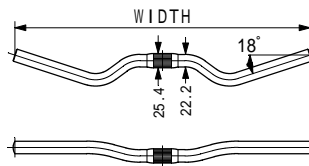

MODEL	WIDTH	RISE	REACH	WEIGHT
B206AA	525	15	34	225 g



B245AA

MATERIAL / ALUMINUM
COLOR / SILVER / BLACK ANODIZED

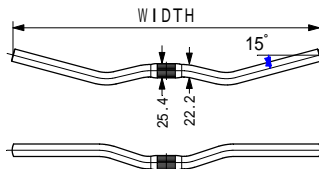

MODEL	WIDTH	RISE	REACH	WEIGHT
B245AA	545	22	14	270 g



B2500AA

MATERIAL / ALUMINUM
COLOR / SILVER / BLACK ANODIZED

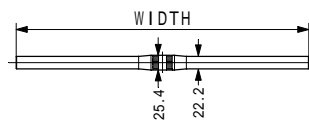

MODEL	WIDTH	RISE	DEPTH	WEIGHT
B2500AA	500	0	0	210 g



B2520AA 25 B2520AA 26

MATERIAL / ALUMINUM
COLOR / SILVER / BLACK ANODIZED

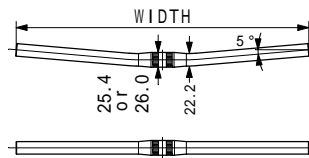

MODEL	WIDTH	RISE	DEPTH	WEIGHT
B2520AA 25	520	0	18	225 g
B2520AA 26				



B2525AA 25 B2525AA 26

MATERIAL / ALUMINUM
COLOR / SILVER ANODIZED

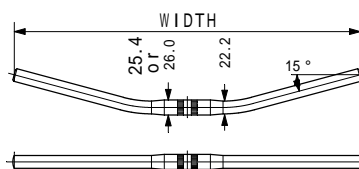

MODEL	WIDTH	RISE	DEPTH	WEIGHT
B2525AA 25	580	0	54	255 g
B2525AA 26				



Urban Cycle Handle bar

B302AA

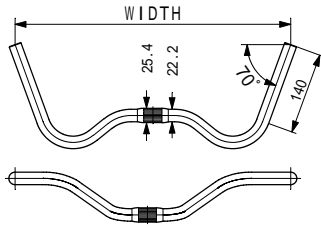

MATERIAL / ALUMINUM
COLOR / SILVER ANODIZED

MODEL	WIDTH	RISE	REACH	WEIGHT
B302AA	490	65	48	360 g

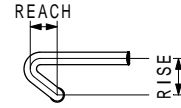

B307AA

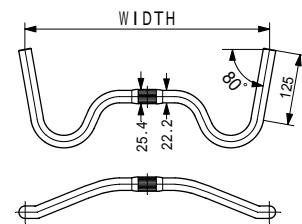

MATERIAL / ALUMINUM
COLOR / SILVER ANODIZED

MODEL	WIDTH	RISE	REACH	WEIGHT
B307AA	435	50	80	360 g

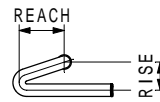

B352AA-HT

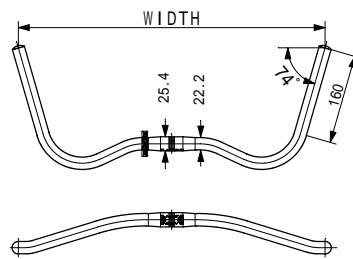

MATERIAL / HEAT TREATED ALUMINUM
COLOR / SILVER ANODIZED

MODEL	WIDTH	RISE	REACH	WEIGHT
B352AA-HT	550	50	35	315 g

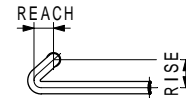

B352EX

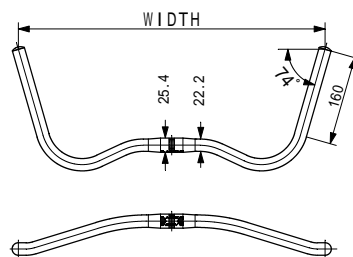

MATERIAL / CrMo
COLOR / SILVER

MODEL	WIDTH	RISE	REACH	WEIGHT
B352EX	550	50	35	555 g

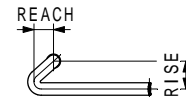

B483AA

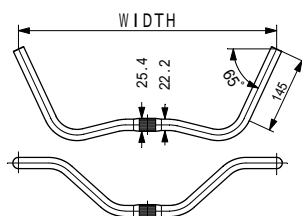

MATERIAL / ALUMINUM
COLOR / SILVER ANODIZED

MODEL	WIDTH	RISE	REACH	WEIGHT
B483AA	510	95	20	365 g

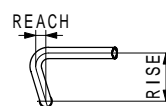



B602AA

MATERIAL / ALUMINUM
COLOR / SILVER ANODIZED

MODEL	WIDTH	RISE	DEPTH	WEIGHT
B602AA	490	68	192	380 g

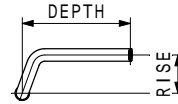
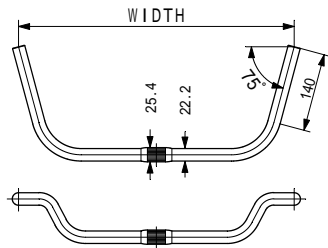

B603AA

MATERIAL / ALUMINUM
COLOR / SILVER ANODIZED

MODEL	WIDTH	RISE	DEPTH	WEIGHT
B603AA	480	56	174	365 g

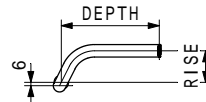
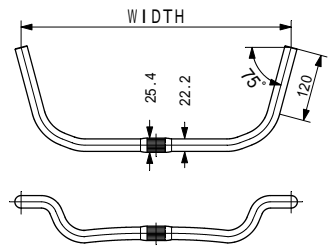

B604AAF

MATERIAL / ALUMINUM
COLOR / SILVER ANODIZED

MODEL	WIDTH	RISE	DEPTH	WEIGHT
B604AAF	530	68	198	340 g

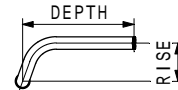
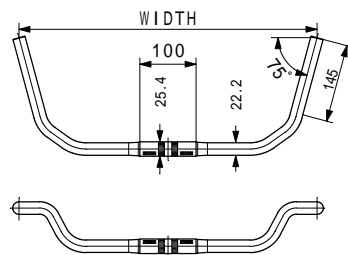

B617AA

MATERIAL / ALUMINUM
COLOR / SILVER ANODIZED

MODEL	WIDTH	RISE	DEPTH	WEIGHT
B617AA	450	0	235	380 g

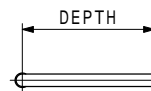
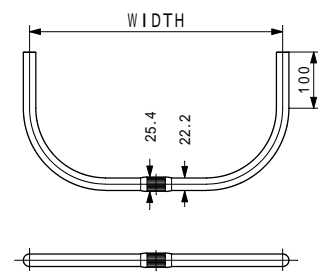

B622AA

MATERIAL / ALUMINUM
COLOR / SILVER ANODIZED

MODEL	WIDTH	RISE	DEPTH	WEIGHT
B622AA	550	0	160	320 g

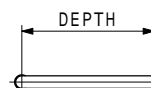
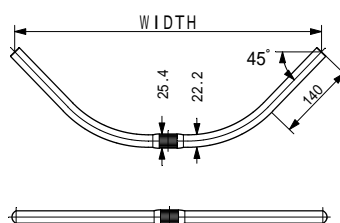



Mountain Bike



B853AA

MATERIAL / HEAT TREATED ALUMINUM
 CENTER DIAM / 25.4mm
 BAR DIAM / 22.2mm
 COLOR / SILVER / BLACK ANODIZED

MODEL	WIDTH	RISE	BACK SWEEP	WEIGHT
B853AA	580	0	5 °	195 g



B801AA-SSB

MATERIAL / HEAT TREATED ALUMINUM
 CENTER DIAM / 31.8mm
 BAR DIAM / 22.2mm
 COLOR / SILVER / BLACK ANODIZED

MODEL	WIDTH	RISE	BACK SWEEP	WEIGHT
B801AA-SSB	730	48	15 °	395 g



B809AA-SSB

MATERIAL / HEAT TREATED ALUMINUM
 CENTER DIAM / 31.8mm
 BAR DIAM / 22.2mm
 COLOR / SILVER / BLACK ANODIZED

MODEL	WIDTH	RISE	BACK SWEEP	WEIGHT
B809AA-SSB	730	32	8 °	385 g



B809AA

MATERIAL / HEAT TREATED ALUMINUM
 CENTER DIAM / 25.4mm
 BAR DIAM / 22.2mm
 COLOR / SILVER / BLACK ANODIZED

MODEL	WIDTH	RISE	BACK SWEEP	WEIGHT
B809AA	630	22	10 °	305 g



B840AA-SSB

MATERIAL / HEAT TREATED ALUMINUM
 CENTER DIAM / 31.8mm
 BAR DIAM / 22.2mm
 COLOR / SILVER / BLACK ANODIZED

MODEL	WIDTH	RISE	BACK SWEEP	WEIGHT
B840AA-SSB	720	21	8 °	298 g

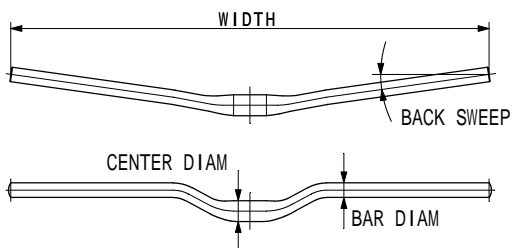



Road Racing

UI-21EX (SILVER)

UI-21

MATERIAL / FORGED ALUMINUM

BAR CLAMP / 31.8 mm

POST CLAMP / 28.6 mm

UI-21BX (BLACK)



31.8

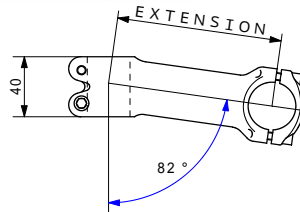

MODEL	EXTENSION	WEIGHT
UI-21-60	60	140 g
UI-21-70	70	145 g
UI-21-80	80	150 g
UI-21-90	90	155 g
UI-21-100	100	160 g
UI-21-110	110	165 g
UI-21-120	120	170 g

UI-22BX (BLACK)

UI-22

MATERIAL / FORGED ALUMINUM

BAR CLAMP / 31.8 mm

POST CLAMP / 28.6 mm

UI-22EX (SILVER)



31.8

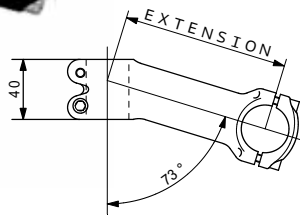

MODEL	EXTENSION	WEIGHT
UI-22-70	70	155 g
UI-22-80	80	160 g
UI-22-90	90	165 g
UI-22-100	100	170 g
UI-22-110	110	175 g
UI-22-120	120	180 g

UI-85EX (SILVER)

UI-85

MATERIAL / FORGED ALUMINUM

BAR CLAMP / 26.0 mm

POST CLAMP / 28.6 mm

25.4mm Shim Attachment

UI-85BX

(SHINY BLACK)

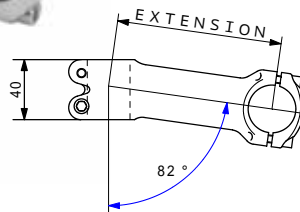

MODEL	EXTENSION	WEIGHT
UI-85-60	60	145 g
UI-85-70	70	150 g
UI-85-80	80	155 g
UI-85-90	90	160 g
UI-85-100	100	165 g
UI-85-110	110	170 g
UI-85-120	120	175 g

UI-86BX (SHINY BLACK)

UI-86

MATERIAL / FORGED ALUMINUM

BAR CLAMP / 26.0 mm

POST CLAMP / 28.6 mm

25.4mm Shim Attachment

UI-86EX (SILVER)

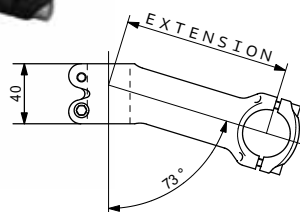

MODEL	EXTENSION	WEIGHT
UI-86-60	60	145 g
UI-86-70	70	150 g
UI-86-80	80	155 g
UI-86-90	90	160 g
UI-86-100	100	165 g
UI-86-110	110	170 g
UI-86-120	120	175 g

UI - 25 EX (CNC)



EX (SILVER)

BAR CLAMP
31.8

UI - 25 BX (CNC)



BX
(SHINY BLACK)

CNCシステム切削加工 《computer numerical control》

MATERIAL / HEAT TREATED ALUMINUM
EXTENSION / 60 ~ 120 mm every 10 mm
BAR CLAMP / 31.8 mm
POST CLAMP / 28.6 mm
ANGLE / 85°
WEIGHT / 118 ~ 154 g
COLOR / SILVER (EX)
/ BLACK (BX) ANODIZED

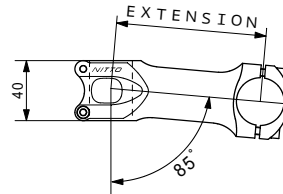

UI - 87 EX
(CNC)
EX (SILVER)

37

UI - 87 BX (CNC)

BX
(SHINY BLACK)

BAR CLAMP
26.0

CNCシステム切削加工 《computer numerical control》

MATERIAL / HEAT TREATED ALUMINUM
EXTENSION / 80 ~ 110 mm every 10 mm
BAR CLAMP / 26.0 mm
POST CLAMP / 28.6 mm
ANGLE / 85°
WEIGHT / 128 ~ 148 g
COLOR / SILVER (EX)
/ BLACK (BX) ANODIZED

UI - 75 EX
EX (SILVER)

UI - 75 BX

BX
(SHINY BLACK)

BAR CLAMP
25.4

MATERIAL / FORGED ALUMINUM
BAR CLAMP / 25.4 mm
POST CLAMP / 28.6 mm

MODEL	EXTENSION	WEIGHT
UI-75- 60	60	130 g
UI-75- 70	70	135 g
UI-75- 80	80	140 g
UI-75- 90	90	145 g
UI-75-100	100	150 g
UI-75-110	110	155 g
UI-75-120	120	160 g

Clamp On UI-12

MATERIAL / CrMo
BAR CLAMP / 31.8
POST CLAMP / 28.6
COLOR / SILVER

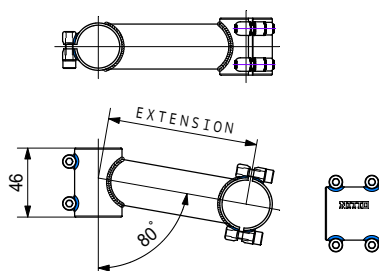

MODEL	EXTENSION	WEIGHT
Clamp On UI-12 - 60	60	190 g
Clamp On UI-12 - 70	70	195 g
Clamp On UI-12 - 80	80	205 g
Clamp On UI-12 - 90	90	215 g
Clamp On UI-12 - 100	100	225 g
Clamp On UI-12 - 110	110	235 g
Clamp On UI-12 - 120	120	245 g



Road Racing



CT - 1

26.0
BAR CLAMP

MATERIAL / CrMo
EXTENSION / 80 ~ 120 mm every 10 mm
BAR CLAMP / 26.0 mm
POST DIAM / 22.2 mm
POST LENGTH / 140mm
ANGLE / 72°
WEIGHT / 365 ~ 385g
COLOR / SILVER (メッキ)

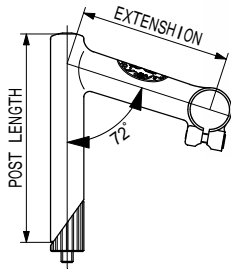

CT - 2

25.4
BAR CLAMP

MATERIAL / CrMo
EXTENSION / 80 ~ 120 mm every 10 mm
BAR CLAMP / 25.4 mm
POST DIAM / 22.2 mm
POST LENGTH / 140mm
ANGLE / 72°
WEIGHT / 370 ~ 390g
COLOR / SILVER (メッキ)



UI - 12

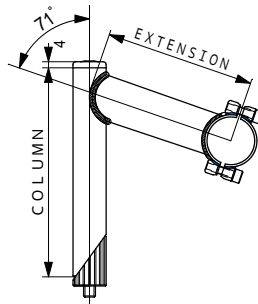

MATERIAL / CrMo
BAR CLAMP / 31.8
POST DIAM / 22.2
COLOR / SILVER

MODEL	EXTENSION	COLUMN	WEIGHT
UI-12 - 60	60	140	310 g
UI-12 - 70	70		320 g
UI-12 - 80	80		330 g
UI-12 - 90	90		340 g
UI-12 - 100	100		350 g
UI-12 - 110	110		360 g
UI-12 - 120	120		370 g



UI - 2

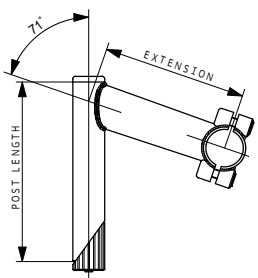

MATERIAL / CrMo
BAR CLAMP / 26.0
POST DIAM / 22.2
COLOR / SILVER

MODEL	EXTENSION	COLUMN	WEIGHT
UI-2 - 60	60	115	252 g
UI-2 - 70	70	125	270 g
UI-2 - 80	80		278 g
UI-2 - 90	90	137	300 g
UI-2 - 100	100		308 g
UI-2 - 110	110		316 g
UI-2 - 120	120		329 g



MTC-01
MTC-02
MTC-04-225

	UPPER	LOWER	POST LENGTH	WEIGHT
MTC -01	25.4mm	22.2mm	130mm	170 g
MTC -02	28.6mm	25.4mm	130mm	180 g
MTC-023	28.6mm	28.6mm	130mm	175 g
MTC-024	28.6mm	22.2mm	130mm	180 g
MTC -04-225 (28.6-22.2)			225mm	250 g

MATERIAL / ALUMINUM
COLOR / SILVER ANODIZED

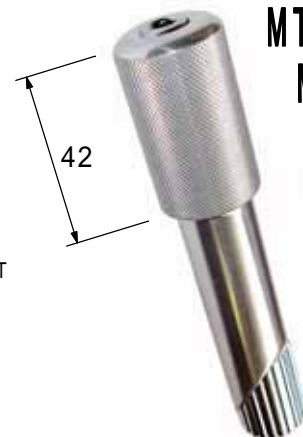

MTC-023
MTC-024



NP - (60~70)

MATERIAL / FORGED ALUMINUM
 EXTENSION / 60 - 70mm
 ANGLE / 71 °
 BAR CLAMP / 25.4/ 26.0mm 1
 POST DIAM / 22.2mm
 POST LENGTH / 150mm
 WEIGHT / 280 ~ 290g
 COLOR / SILVER ANODIZED

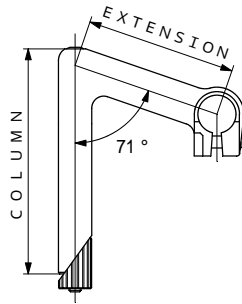

NP - (80~120)

MATERIAL / FORGED ALUMINUM
 EXTENSION / 80 ~ 120mm / every 10mm
 ANGLE / 71 °
 BAR CLAMP / 25.4/ 26.0mm 1
 POST DIAM / 22.2mm
 POST LENGTH / 150mm
 WEIGHT / 300 ~ 360g
 COLOR / SILVER ANODIZED

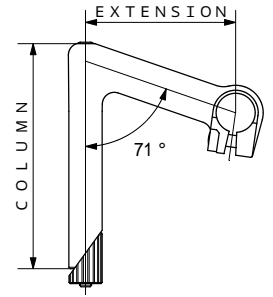

NTC - (50~130)-150

MATERIAL / FORGED ALUMINUM
 EXTENSION / 50 ~ 130mm
 every 10mm
 ANGLE / 71 °
 BAR CLAMP / 25.4mm
 POST DIAM / 22.2mm
 POST LENGTH / 150mm
 WEIGHT / 280 ~ 360 g
 COLOR / SILVER



NTC - A (80~120)

MATERIAL / FORGED ALUMINUM
 EXTENSION / 80 ~ 120mm
 /every 10mm
 ANGLE / 72 °
 BAR CLAMP / 25.4/ 26.0mm 2
 POST DIAM / 22.2mm
 POST LENGTH / 145mm
 WEIGHT / 300 ~ 340 g
 COLOR / SILVER ANODIZED

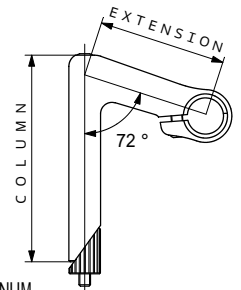

NTC - (50~130)-225

MATERIAL / FORGED ALUMINUM
 EXTENSION / 50 ~ 130mm
 / every 10mm
 ANGLE / 71 °
 BAR CLAMP / 25.4mm
 POST DIAM / 22.2mm
 POST LENGTH / 225mm
 WEIGHT / 345 ~ 475 g
 COLOR / SILVER

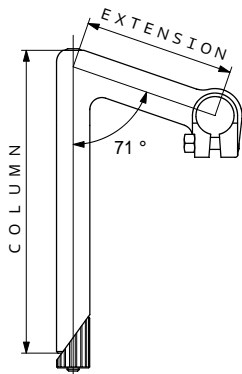

NTC - (50~100)-280

MATERIAL / FORGED ALUMINUM
 EXTENSION / 50 ~ 100mm
 / every 10mm
 ANGLE / 71 °
 BAR CLAMP / 25.4mm
 POST DIAM / 22.2mm
 POST LENGTH / 280mm
 WEIGHT / 375 ~ 425 g
 COLOR / SILVER



NY3 (70~100)

MATERIAL / ALUMINUM
 EXTENSION / 70 ~ 100mm /every 10mm
 ANGLE / 72 °
 BAR CLAMP / 25.4mm
 POST DIAM / 22.2mm
 POST LENGTH / 160mm
 WEIGHT / 300 ~ 360 g
 COLOR / SILVER

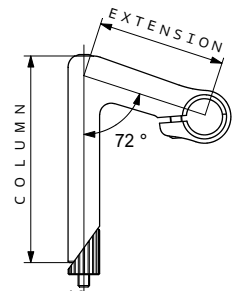

1 It is difficult to assemble anatomic shape handlebar such as M106NAS on this stem, even with stem wrench.

1 アナトミックのタイプのバー及びM106NASには、オープンスパナ(組立工具)を使用しても、組立てが非常に困難です。

2 Because of clamp shape anatomic type bent bars cannot be installed.

2 アナトミックのタイプのバー及びM106NASには、組付られません。



MT-10DX-80

MATERIAL / FORGED ALUMINUM
 EXTENSION / 80mm
 ANGLE / 35 ° UP
 BAR CLAMP / 26.0mm
 POST DIAM / 22.2mm
 POST LENGTH / 190mm
 WEIGHT / 340 g
 COLOR / SILVER ANODIZED



MT-10DX-100

MATERIAL / FORGED ALUMINUM
 EXTENSION / 100mm
 ANGLE / 35 ° UP
 BAR CLAMP / 26.0mm
 POST DIAM / 22.2mm
 POST LENGTH / 190mm
 WEIGHT / 360 g
 COLOR / SILVER ANODIZED

MT-10-80

MATERIAL / FORGED ALUMINUM
 EXTENSION / 80mm
 ANGLE / 35 ° UP
 BAR CLAMP / 25.4mm
 POST DIAM / 22.2mm
 POST LENGTH / 160 / 225mm
 WEIGHT / 325 / 358 g
 COLOR / SILVER

MT-10-100

MATERIAL / FORGED ALUMINUM
 EXTENSION / 100mm
 ANGLE / 35 ° UP
 BAR CLAMP / 25.4mm
 POST DIAM / 22.2mm
 POST LENGTH / 160 / 225mm
 WEIGHT / 345 / 378 g
 COLOR / SILVER

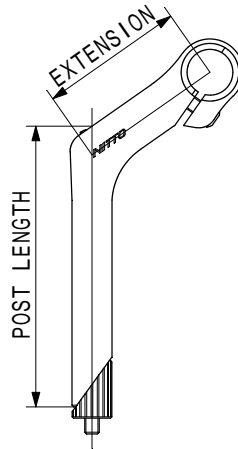

FU-82DX-190

MATERIAL / FORGED ALUMINUM
 EXTENSION / 80mm
 ANGLE / 30 ° UP
 BAR CLAMP / 25.4mm
 POST DIAM / 22.2mm
 POST LENGTH / 190mm
 WEIGHT / 330 g
 COLOR / SILVER ANODIZED



FU-82-260

MATERIAL / FORGED ALUMINUM
 EXTENSION / 80mm
 ANGLE / 30 ° UP
 BAR CLAMP / 25.4mm
 POST DIAM / 22.2mm
 POST LENGTH / 260mm
 WEIGHT / 375 g
 COLOR / SILVER





Seat Post

S 6 5

MATERIAL / FORGED ALUMINUM
 POST DIAM /
 26.8 , 27.0 , 27.2 //31.6mm
 OFFSET / 24mm
 LENGTH / 250 , 300mm //300mm
 WEIGHT / 250 , 280 g //295 g
 COLOR / SILVER ANODIZED
 / BLACK ANODIZED
 27.2 - L250mm size only
 31.6 - L300mm size only

* 1)



S 8 4

MATERIAL /
 BODY Cr.Mo.
 CLAMP
 FORGED ALUMINUM
 POST DIAM /
 27.2mm
 OFFSET / 37mm
 LENGTH / 250mm
 WEIGHT / 345 g
 COLOR / SILVER

* 1)



S 8 3

MATERIAL /
 FORGED ALUMINUM
 POST DIAM /
 26.8 , 27.0 , 27.2mm
 OFFSET / 23mm
 LENGTH / 250 , 300mm
 WEIGHT / 275 , 300 g
 COLOR /
 SILVER ANODIZED

* 1)



S 9 2

MATERIAL /
 FORGED ALUMINUM
 POST DIAM / 27.2mm
 OFFSET / 0 mm
 LENGTH /
 250 , 300 , 350mm
 WEIGHT /
 292 , 322 , 348 g
 (30.9 350mm 350 g)
 (31.6 350mm 350 g)
 COLOR /
 SILVER ANODIZED
 BLACK ANODIZED

* 1)

この商品は、(一財)自転車産業振興協会が実施した平成28年度新商品・新技術研究開発事業により開発されたものです。



Seat Post SP 6 0

MATERIAL / POST ALUMINUM
 / LUG STEEL
 POST DIAM / 27.2mm
 OFFSET / 17mm
 LENGTH / 270mm
 WEIGHT / 310g
 COLOR / SILVER

* 1)



* 1) Do not use a saddle with carbon fiber rails.
 This seat post is not compatible with them.

* 1) カーボン製レールのサドルには、非対応です。



Campee-REAR

for 26" Wheels

MATERIAL / STEEL TUBE
WEIGHT / 1,200 g
COLOR / SILVER
MAXIMUM PAYLOAD / 1.6 kg



Campee-FRONT

for 26" Wheels

MATERIAL / STEEL TUBE
WEIGHT / 1,185 g
COLOR / SILVER
MAXIMUM PAYLOAD / 1.6 kg



Campee-27-REAR

for 27" Wheels

MATERIAL / STEEL TUBE
WEIGHT / 1,215 g
COLOR / SILVER
MAXIMUM PAYLOAD / 1.6 kg

ステー交換部品付属
Comes with two kinds of stays



Campee-27-FRONT

for 27" Wheels

MATERIAL / STEEL TUBE
WEIGHT / 1,055 g
COLOR / SILVER
MAXIMUM PAYLOAD / 1.6 kg



MT-Campee REAR-R20

for 26" Wheels

MATERIAL / STEEL TUBE
WEIGHT / 780 g
COLOR / SILVER
MAXIMUM PAYLOAD / 1.7 kg

ステー交換部品付属
Comes with two kinds of stays



MT-Campee FRONT-F20

for 26" Wheels

MATERIAL / STEEL TUBE
WEIGHT / 1,040 g
COLOR / SILVER
MAXIMUM PAYLOAD / 1.7 kg

Carrier

FRONT-M18

for 26" or 27" Wheels



MATERIAL / CrMo STEEL TUBE
WEIGHT / 350 g
COLOR / SILVER
BLACK
MAXIMUM PAYLOAD / 5kg
Clamp for 20mm round and
22mm oval fork blade
クリップ(バンド)仕様
外径 20mm用 22mmオーバル用

WARNING!
FRONT-M18 is designed to use for support
of handlebar bag.
Do not mount metal basket on this rack.

注意
FRONT-M18は、フロントバッグを乗せるためのキャリアです。
金属製の前カゴ等は、取付けないでください。

Rear Bag Supporter R10



Seat Post DIAM
26.8 ~ 27.2

for 26" or 27" Wheels

MATERIAL / STEEL TUBE
WEIGHT / 390 g
COLOR / SILVER
MAXIMUM PAYLOAD / 10kg
Clamp for 15mm
seat stay
クリップ(バンド)仕様
外径 15mm用

Rear Bag Supporter R15



for 26" or 27" Wheels

MATERIAL / STEEL TUBE
WEIGHT / 790 g
COLOR / SILVER
MAXIMUM PAYLOAD / 10kg
Upper: Clamp for 15mm
seat stay
Lower: Clamp for 12mm and
20mm seat stay
クリップ(バンド)仕様
上部: 外径 15mm用
下部: 外径 12mm用
外径 20mm用

Rear Bag Supporter R26

for 26" or 27" Wheels



MATERIAL / STEEL TUBE
WEIGHT / 810 g
COLOR / SILVER
MAXIMUM PAYLOAD / 10kg
Clamp for 15mm
クリップ(バンド)仕様
外径 15mm用

Rear Bag Supporter R12



MATERIAL / STEEL
WEIGHT / 178 g
COLOR / SILVER
MAXIMUM PAYLOAD / 1.2kg



Touring

Front Bag Supporter F-018

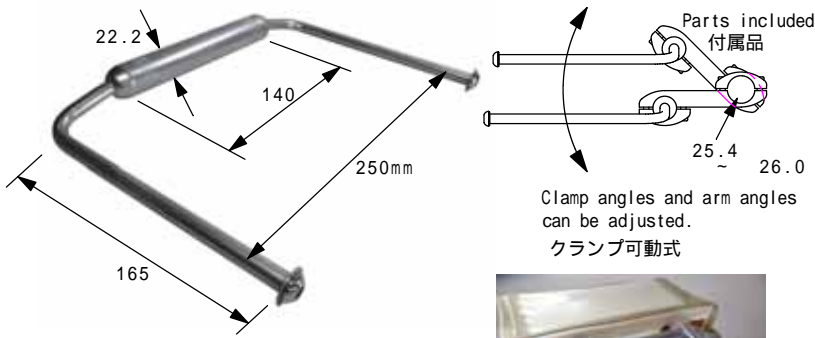

A handlebar and a bag are sold separately.
バックとハンドルバーは、別途ご購入下さい



Front Bag Supporter F-019

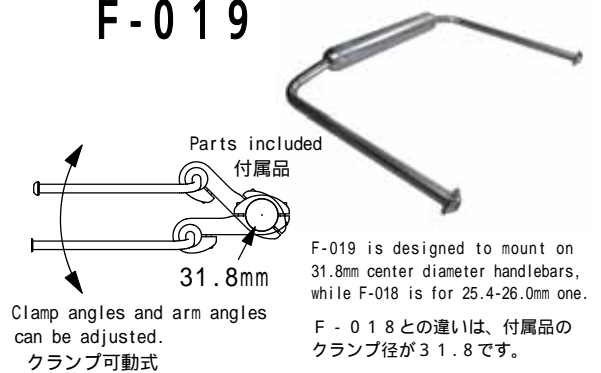

A handlebar and a bag are sold separately.
バックとハンドルバーは、別途ご購入下さい

F-019 is designed to mount on 31.8mm center diameter handlebars, while F-018 is for 25.4-26.0mm one.
F-018との違いは、付属品のクランプ径が31.8です。

FRONT-F16

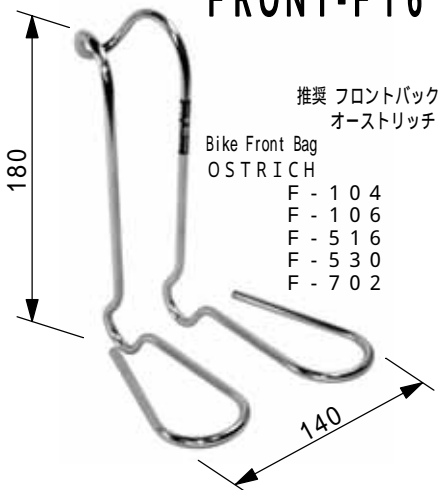

FRONT-M12

for 26" or 27" Wheels

MATERIAL / STEEL TUBE
WEIGHT / 255g
COLOR / SILVER
MAXIMUM PAYLOAD / 2kg



With Double Threaded Bolt

WARNING!

FRONT-M12 is designed to use for support of handlebar bag.
Do not mount metal basket on this rack.

注意

FRONT-M12は、フロントバックを乗せるためのキャリアです。
金属製の前カゴ等は、取付けないでください。

DECALEURS ZL-60P(ZAO)

For NP Stem
MATERIAL / STEEL TUBE
COLOR / SILVER

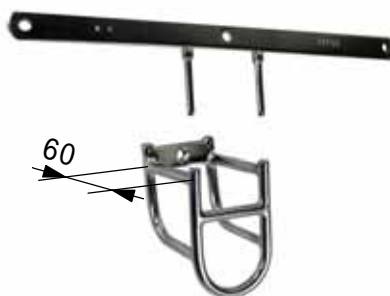

Install the "ZAO" on a Nitto "NP" stem.
Do not install the "ZAO" on other brand stems.

NP (N-P) 専用

NP (N-P)・NTC には、取付きません。

The "ZAO" is designed exclusively for Nitto "NP" stems.

It is not compatible with Nitto "NP" "NTC" or other Nitto stems.

オプション

バッグ内側の取付け部を補強する、背板は別売りです。

Wire Guard Protect For Saddle Bag

MATERIAL / STAINLESS STEEL
WEIGHT / 30g

Mounts easily and securely to the seat stays.
Made out of stainless steel for anti rusting.
Neat looking, good on touring bikes.

製品全体がスプリングになっています。
シート・ステーに簡単に取り付けることが出来て、しっかり固定します。
外観もスッキリ楽しいツーリングをお楽しみいただけます。
サビにくいステンレス素材を使用しています。



Accessories

Lamp Holder 3

MATERIAL / STAINLESS STEEL TUBE
SCREW / M 6
WEIGHT / 55g



Front Carrier M 1 2



Lamp Holder 4

MATERIAL / STAINLESS STEEL TUBE
SCREW / M 5
WEIGHT / 55g



Lamp Holder 31.8

BODY / FORGED ALUMINUM
BAR CLAMP / 31.8mm
SHORT BAR DIAM / 23.8mm
LENGTH / 50, 90mm
WEIGHT / 96g(BAR50mm)



31.8

23.8



26.0

Lamp Holder 70

BODY / FORGED ALUMINUM
BAR CLAMP / 26.0mm
SHORT BAR DIAM / 23.8mm
LENGTH / 50, 90mm
WEIGHT / 92g(BAR50mm)



23.8



26.0

Lamp Holder 2-70



22.2

BODY / FORGED ALUMINUM
BAR CLAMP / 26.0mm
SHORT BAR DIAM / 22.2mm
LENGTH / 200mm
WEIGHT / 235g



Lamp Holder 6 L Lamp Holder 6 R



FOR M18 FRONT CARRIER
MATERIAL / STAINLESS STEEL / STEEL

6 L

Riding Right side of the road (e.g. U.S.A.)

6 R

Riding Left side of the road (e.g. Japan, U.K.)



Lamp Holder 8 L Lamp Holder 8 R



FOR M12 FRONT CARRIER
/ Campee FRONT
MATERIAL / STAINLESS STEEL / STEEL

8 L

Riding Right side of the road (e.g. U.S.A.)

8 R

Riding Left side of the road (e.g. Japan, U.K.)



Accessories

Outer Cable Stopper

AS - 1
for TOURING
Stopper / STEEL
Adjustment Screw / ALUMINUM
WEIGHT / 7g

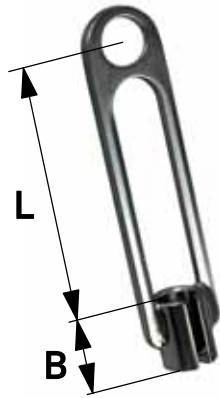

AS - 2
Stopper / STEEL
L / 45mm
B / 13mm
WEIGHT / 7g

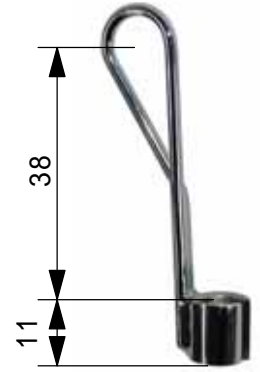

AS - 3
Stopper / STEEL
L / 35mm
B / 11mm
WEIGHT / 6g

AS - 5
Stopper / STEEL
WEIGHT / 7g

Stays(for carrir) ツナギロッド(キャリア用交換部品)

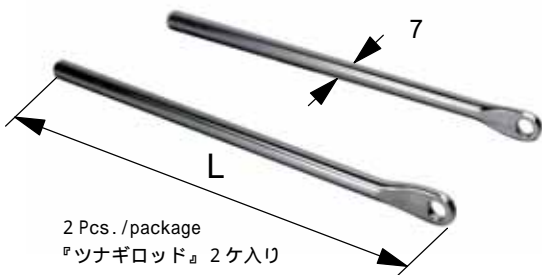

MATERIAL:ALUMINUM
COLOR:SILVER

MODEL	L
CF059	150mm
	180mm
	350mm
	420mm

Bolt Cap

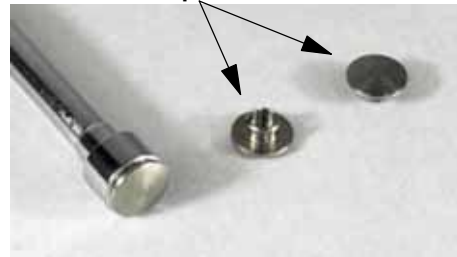

For Bolt

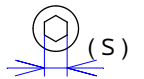

MATERIAL:STAINLSS STEEL
WEIGHT:(1g)
COLOR:SILVER

MODEL	(S)	For Bolt
Bolt Cap M 8	6 mm	M 8
Bolt Cap M 6	5 mm	M 6
Bolt Cap M 5	4 mm	M 5

Bar End Cap EC-01 (Bar Diam 24)

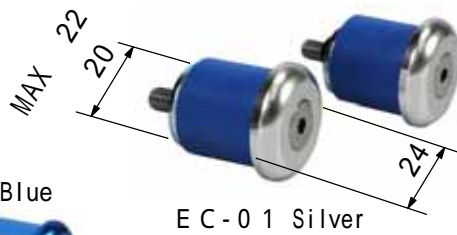

WEIGHT / 25g x 2

Inside Diameter of Bar 20 ~ 22mm



Bar End Cap EC-02 (Bar Diam 22.2)

Two sizes of rubber bush included
ブッシュサイズ2種類入り

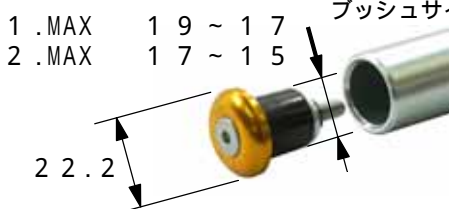



Bottle Cage 80

MATERIAL / STAINLESS STEEL TUBE
WEIGHT / 48.5g



Bottle Cage T

MATERIAL / STAINLESS STEEL
WEIGHT / 55g



Bottle Cage R

MATERIAL / STAINLESS STEEL
WEIGHT / 53g



Bottle Cage 500

MATERIAL / STAINLESS STEEL
WEIGHT / 55g

Stem Tool 4



Designed to be used with:

CrMo Stems / CT-1, CT-2, LS100...etc

Al Stems / NP, NP , NTC...etc

MATERIAL / STEEL

WEIGHT / 138g



Stainless Shim

MATERIAL / STAINLESS STEEL

WEIGHT / 8g

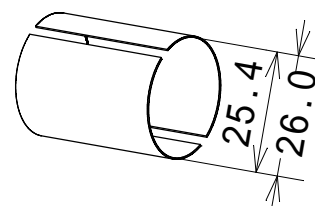

for 27" Wheels

Attachment for

EX



Standard
(for SHIMANO)



Option Attachment
(for CAMPAGNOLO)

CYCLE STAND EX

MATERIAL / STEEL TUBE
WEIGHT / 700 g
COLOR / SILVER

CYCLE STAND EX-20



for 20" Wheels

T Shirt



Blue

American size
S , M , L

Black



Racing Cap



Blue

Black



made in U.S.A.



NITTO Co.,Ltd
Since 1923

3 - 23 - 7 Minami Hatogaya
Kawaguchi Saitama 334-0013 Japan
T E L : 81 - 48 - 286 - 7771
F A X : 81 - 48 - 286 - 7770
E-mail:nitto@violin.ocn.ne.jp
<http://nitto-tokyo.sakura.ne.jp>

No.34 - 2020 **web**

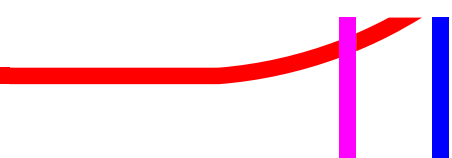

株式会社 日 東

東京事務所 : 〒334-0013

埼玉県川口市南鳩ヶ谷 3 - 23 - 7

T E L : 048-286-7771(代)

F A X : 048-286-7770

E-mail:nitto@violin.ocn.ne.jp

<http://nitto-tokyo.sakura.ne.jp>

本 社 : 東京都荒川区西日暮里 1 - 15 - 5

福島工場 〒964-0938

福島県二本松市安達ヶ原 6 - 151 - 1